

CUP

design Meneghello Paolelli Associati

the.artceram

ISTRUZIONI DI MONTAGGIO ASSEMBLY INSTRUCTIONS

ELEMENTI PRESENTI NELLA CONFEZIONE YOU CAN FIND THE FOLLOWING PIECES INSIDE THE BOX

LAVABO
WASHBASIN

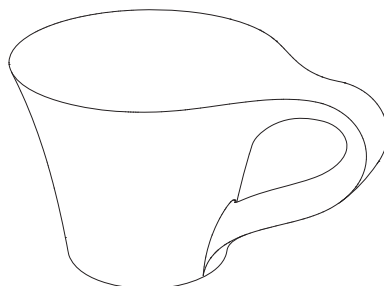

PILETTA
DRAIN



PIASTRE DI FISSAGGIO
PLATES FIXING

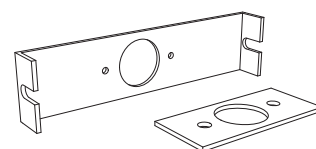

PROLUNGA CANNOTTO DRITTO
EXTENSION DRAINING TUBE



FISSAGGI
FIXING

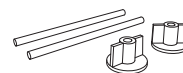

ACCESSORI NECESSARI ACCESSORIES NEEDED

. CHIAVE INGLESE
. PIPE WRENCH

. PENNA
. PEN

. SILICONE
. SILICONE

. LIVELLA
. LEVEL

MADE IN ITALY



ARTCERAM

CUP

design Meneghello Paolelli Associati

the.artceram

ISTRUZIONI DI MONTAGGIO ASSEMBLY INSTRUCTIONS

INSTALLAZIONE DEL LAVABO DA APPOGGIO HOW TO INSTALL THE COUNTER TOP WASHBASIN

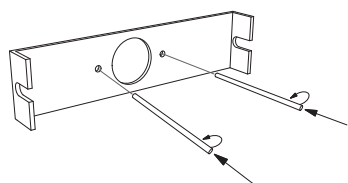

1. Avvitare i perni nella piastra di fissaggio grande in dotazione. Screw the pins in the largest fixing plate included in the package.

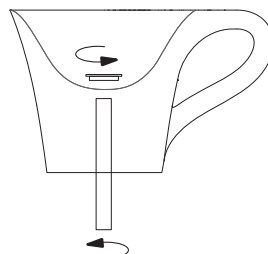

2. Installare la piletta in dotazione sul lavabo, insieme alla prolunga del canotto dritto. Install the included drain on the washbasin, along with the extension draining tube.

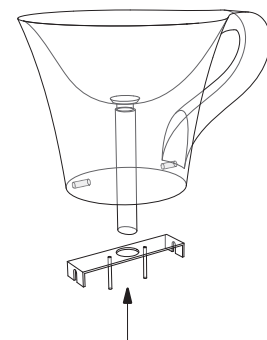

3. Capovolgere il lavabo, e posizionare all'interno la piastra grande con i perni rivolti verso il fondo. Turn the washbasin, and place inside of it the large plate with the pins toward to the bottom.



4. Serrare i bulloni per fissare la piastra posizionata in precedenza. Screw the bolts to fixing the plate located above.

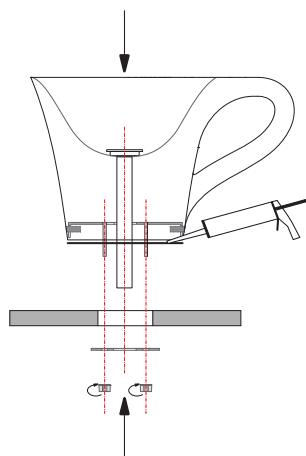

5. Siliconare la base del lavabo prima di appoggiarlo sulla mensola; poi inserite, nelle viti che fuoriescono da sotto, la piastra piccola. Serrate con i dadi in pvc in dotazione. Use silicone to seal the base of the washbasin on the shelf; then put the small plate into the screws that came out from under. Screw with the PVC bolts.

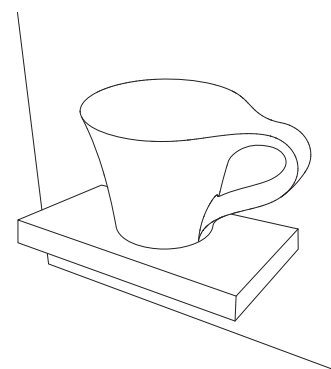

6. Installare ora il vostro sifone sul canotto che fuoriesce dalla mensola. Il lavabo ora è installato! Installare la rubinetteria a muro. Now install your siphon on the extension draining tube that came out of the shelf. The sink is now installed! Install the wall tap.

MADE IN ITALY



ARTCERAM

CUP

design Meneghello Paolelli Associati

the.artceram

ISTRUZIONI DI MONTAGGIO ASSEMBLY INSTRUCTIONS



LIVINGTEC
LIVINGTEC

CARATTERISTICHE, USO E MANUTENZIONE CHARACTERISTICS, USE AND MAINTENANCE

E' prodotto con un materiale compatto la sua composizione è a base idrato di allumina e una bassa percentuale di resina poliestere acrilica materiale piacevole al tatto, la sua omogeneità e brillantezza, il colore lo raggiunge totalmente grazie ad un trattamento di lucidatura, prodotto da trattare con cura ed attenzione .

The livintec is a compact, not porous material. Its composition is based on hydrate of alumina and a small percentage of resins polyester acrylic, a material pleasant to the touch. This material is so uniform and bright thanks to a polish treatment. Please, take care and attention.

CONSIGLI PER LA PULIZIA CLEANING ADVICES

Lavare la superficie dei lavabi esclusivamente con prodotti neutri liquidi. Per risciacquare e asciugare usare: spugne non abrasive, panni morbidi o pelle di "daino".

Wash the surface only with fluid neutral products; to remove soap and dry, use only not-pot scourers, soft clothes or deerskin.

COSE DA NON USARE DON'T USE FOR CLEANING

Pagliette d'acciaio, prodotti anticalcare e prodotti contenenti acidi.

Wire wool, anti-limestone products and acid products.

MADE IN ITALY



ARTCERAM